

# OGRE<sup>®</sup>

# KICKSTARTER

Stretch Goal #5  
Version 1.0 (April 2012)

[ogre.sjgames.com](http://ogre.sjgames.com)

Ogre and the all-seeing pyramid are registered trademarks of Steve Jackson Games.

Kickstarter is a trademark of Kickstarter Inc.

These designs are copyright © 2012 by Steve Jackson Games Incorporated. All rights reserved.  
Line drawings by Richard Kerr, based on designs by Winchell Chung, Richard Kerr, Philip Miller,  
Darrel Philips, Jim Zepeda, and pathetically crude sketches by Steve Jackson.

## COMMAND POST

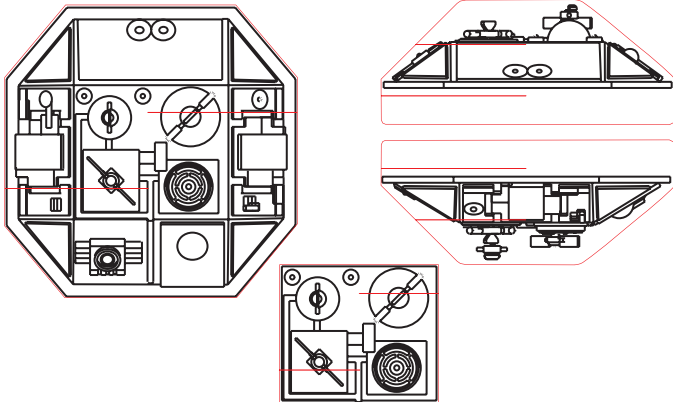

## LASER TURRET

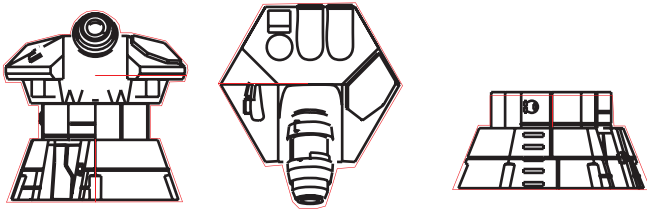

## LASER TOWER

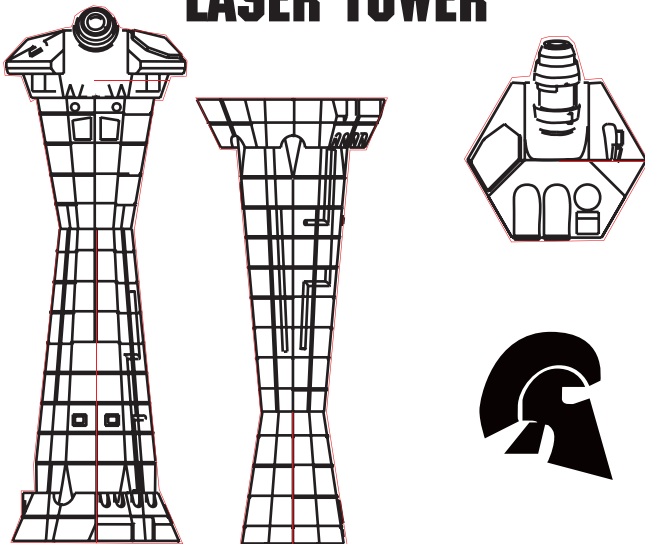

## COMMAND POST

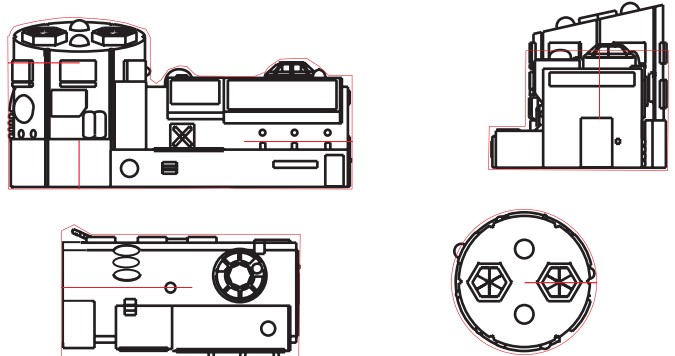

## LASER TURRET

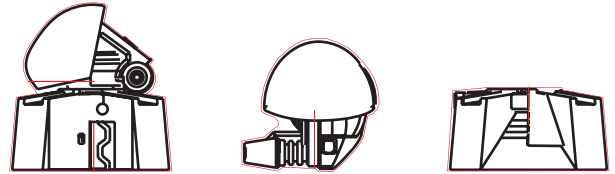

## LASER TOWER

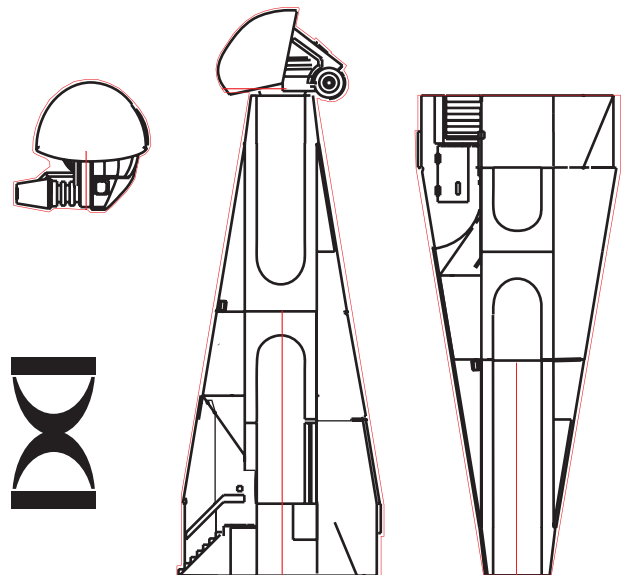

# STEVE JACKSON GAMES



This is the fifth stretch goal for the **Ogre** 6th Edition Kickstarter project. Thanks to our Kickstarter supporters, everybody gets these blank outlines of both sides' Command Posts, Lasers, and Laser Towers - one each with the structure drawn in, and one completely blank. You are welcome to print them out and color them (or vice versa) and build your own buildings for your Ogres to attack. Send us pictures at [ogrepix@sjgames.com](mailto:ogrepix@sjgames.com)!

The slits are shown as lines. Cut them to equal the width of the stock you mount them on. We cut ours out with a laser. Unfortunately, it is not mounted in a tower

and cannot vaporize armor. If you are using a hobby knife, take your time and be careful.

For assembly instructions, see the last page of the PDF.

You may post your colored versions online, as long as the text and images on this sheet are left intact. You may add your name, URL, twitter handle, etc. Please do not SELL the sheets or finished buildings - we made these to be giveaways.

Enjoy!

- Steve Jackson

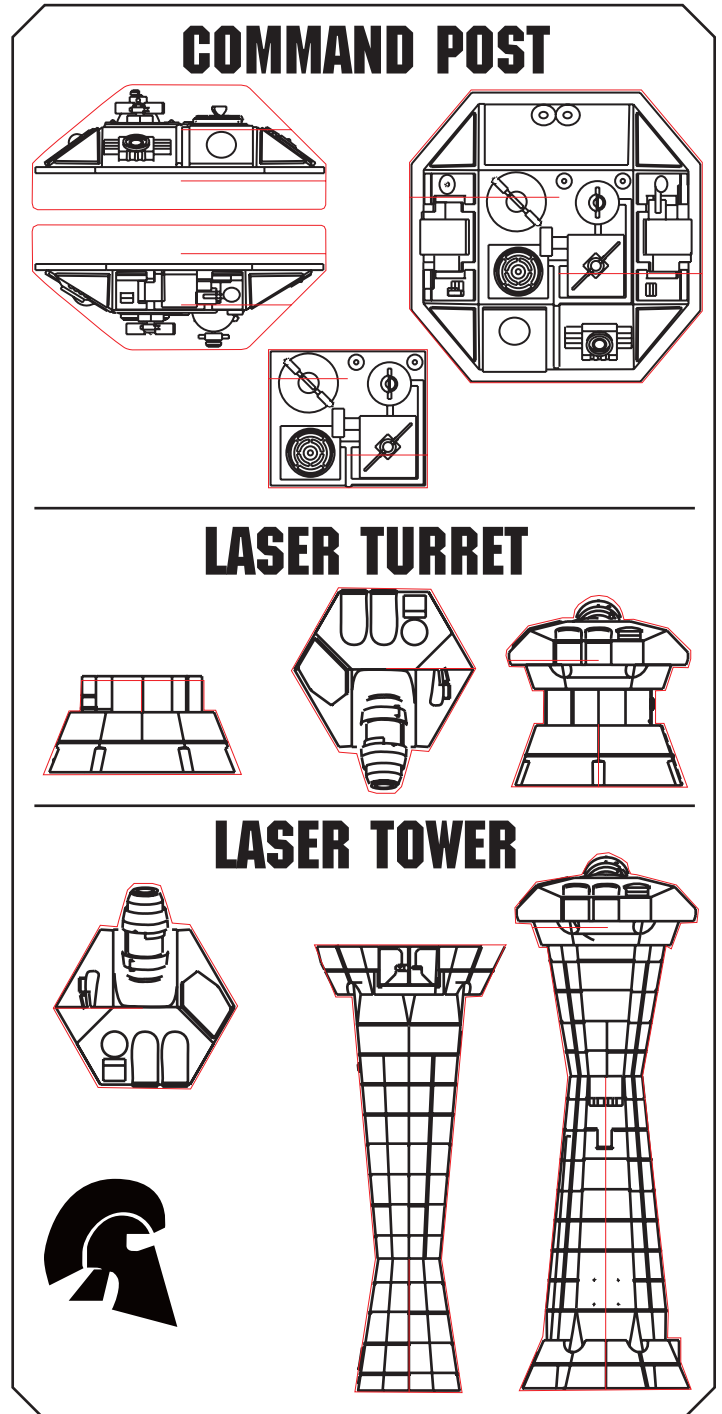
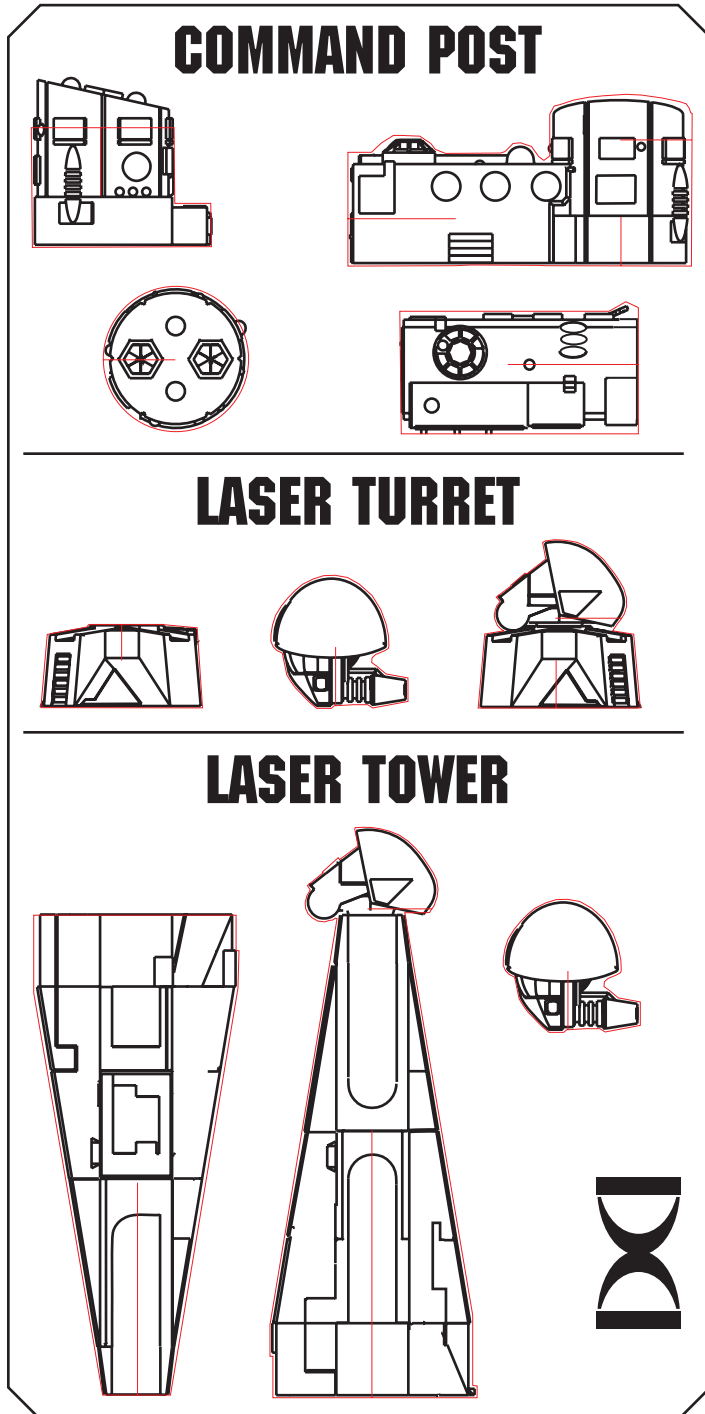

# ASSEMBLED BUILDINGS

**COMMAND POST**

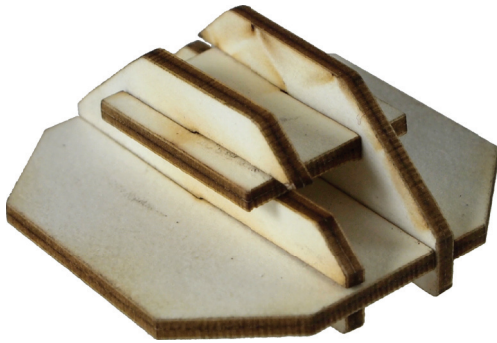

**COMMAND POST**

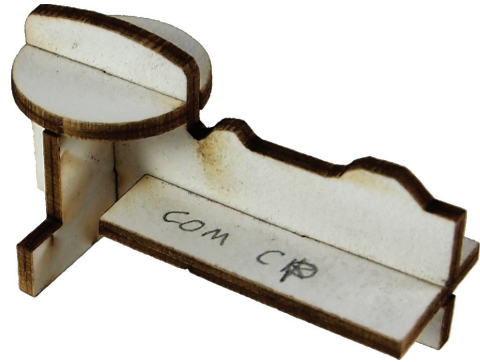

**LASER TURRET**



**LASER TURRET**



**LASER TOWER**



**LASER TOWER**

